

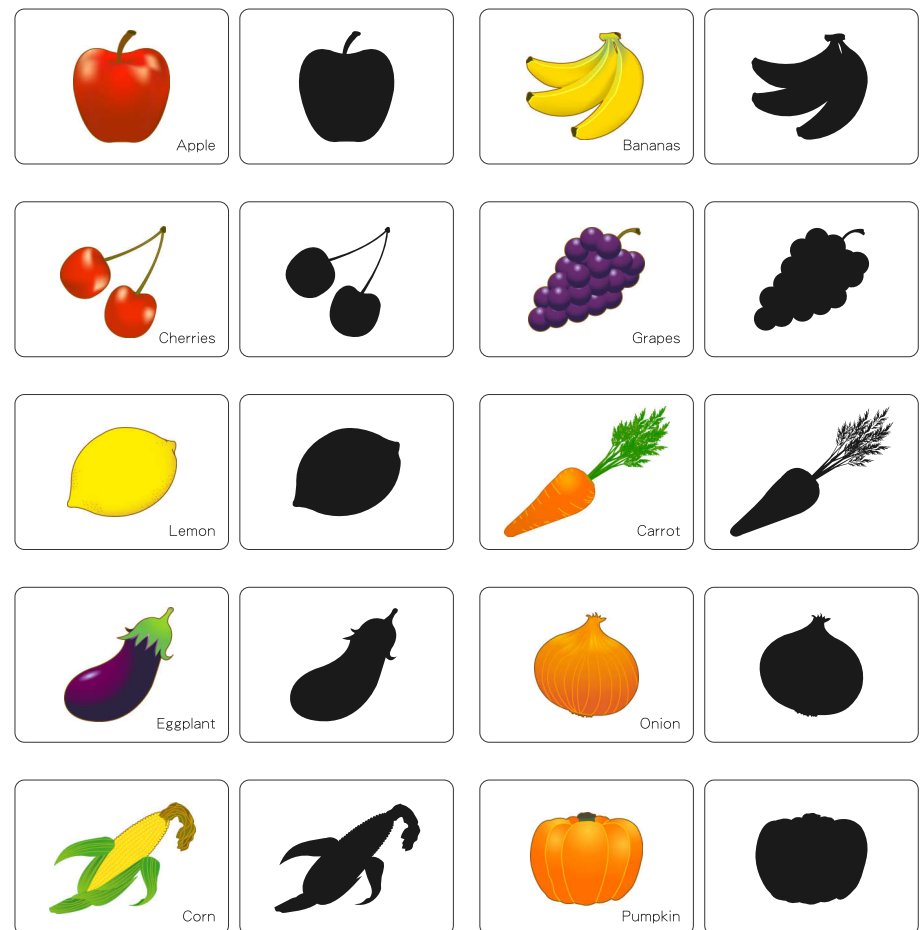

HOW TO PLAY

With these educational flash cards, children guess what an item is by looking at its shadow. The cards encourage children to think about all kinds of things, serving to develop the imagination through play. Children can also learn shapes, colors, and vocabulary as you have fun talking together. The cards can be divided into categories such as fruits, vegetables, or by color. Have fun coming up with your own original games!

[ANSWERS]



HOW TO MAKE

■ Pattern: 7 sheets ■ Assembly Instructions: 2 sheets ■ Number of Parts: 13

You will need: Scissors, glue, ruler, a used ball-point pen

Assembly Tip: Trace along the folds with a ruler and a used pen (no ink) to get a sharper, easier fold.

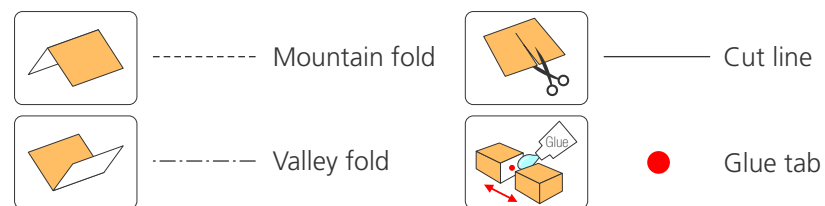

Caution: This craft requires the use of glue, scissors, and other tools which may be dangerous to young children. Please keep them out of reach of children while you work. The finished craft may have sharp corners, so please keep a close eye on children when they play with it. Please also ensure that children do not put the pieces in their mouth as this can be extremely dangerous.

MAKE THE CARDS

1

A 1 ~ A 10
Parts A1 to A10 are made in the same way.

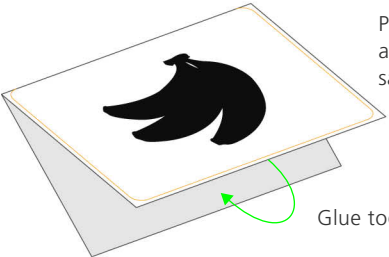

Glue together.

2

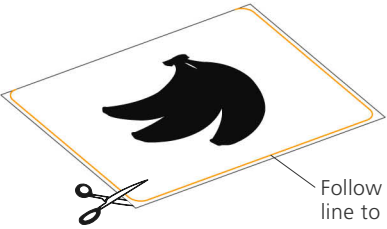

Follow the yellow line to cut out.

3

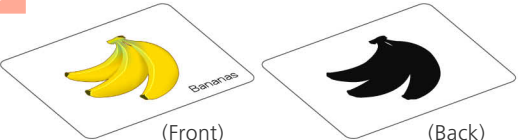

(Front) (Back)

4



ASSEMBLE THE BOX

1



Glue together.

2



Glue to the reverse side.

3



Cut out the blue area.

4



5

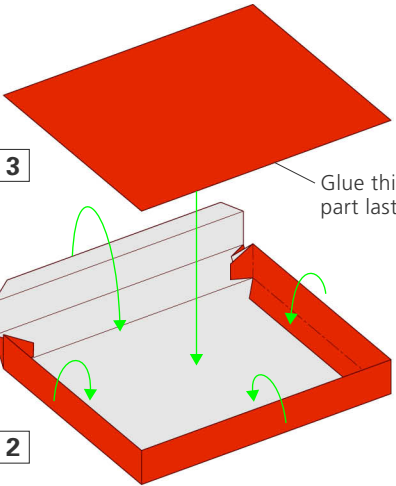

Glue this part last.

6

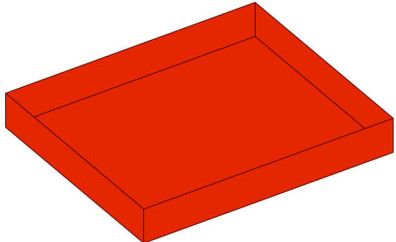

7



Finished!

A 1

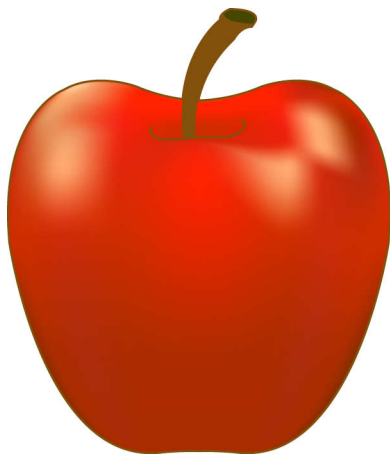
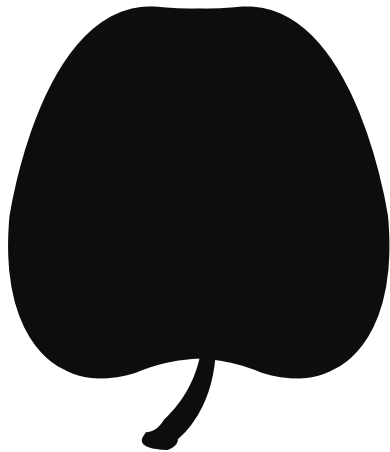

Apple

A 2



Bananas

A 3

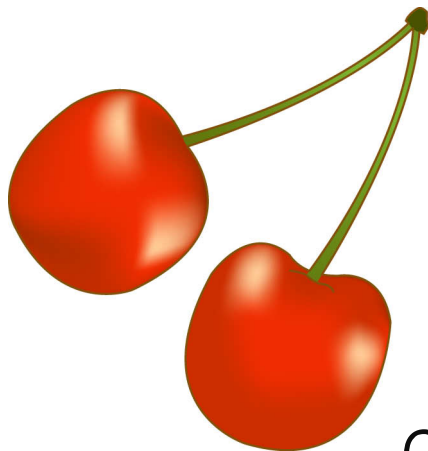
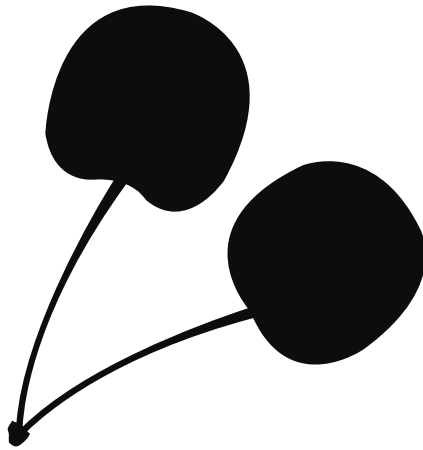

Cherries

A 4

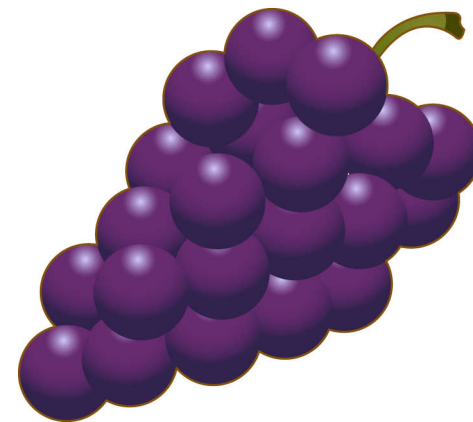

Grapes

A 5

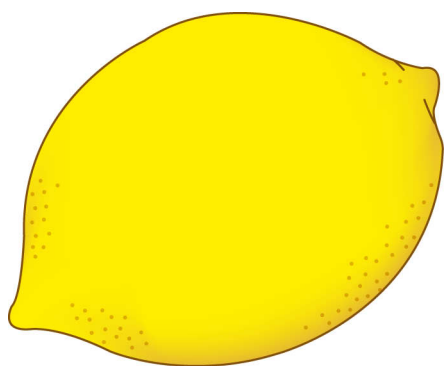
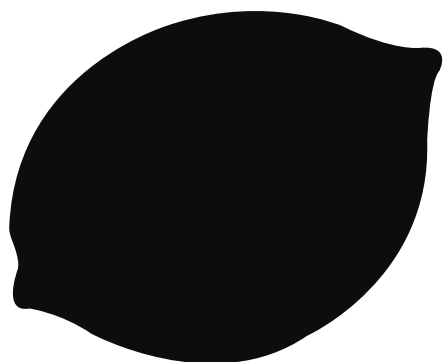

Lemon

A 6

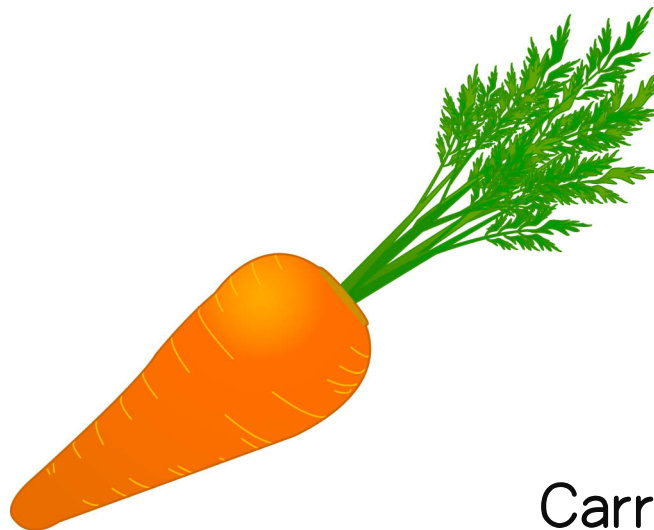

Carrot

A 7

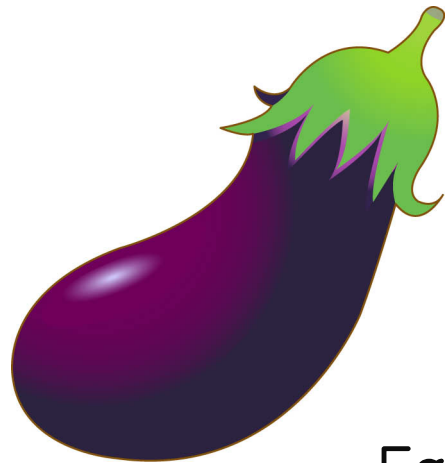

Eggplant

A 8

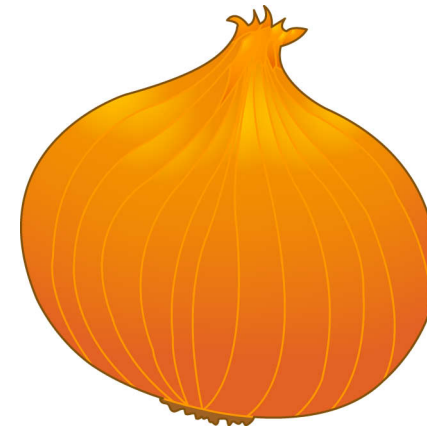
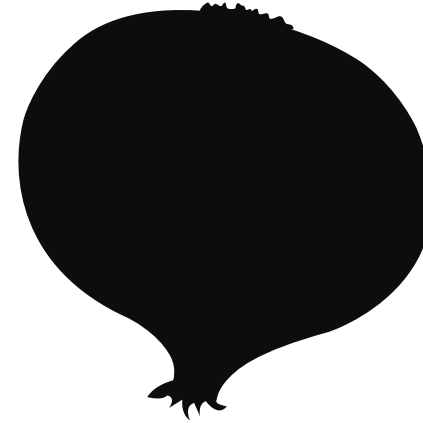

Onion

A 9



Corn

A 10

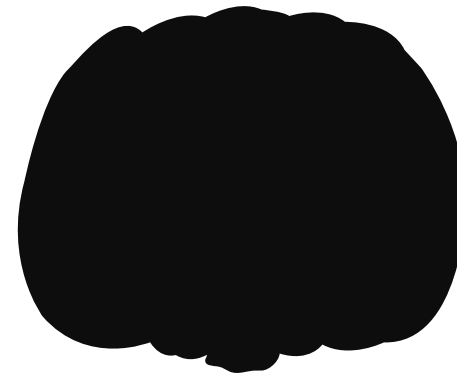

Pumpkin

B 1



B 3

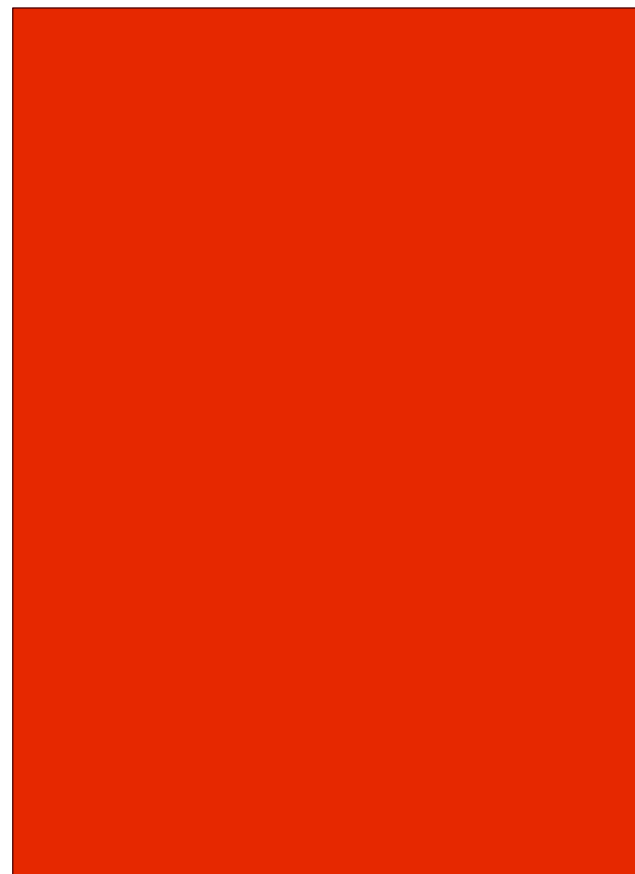

B 2

